

Surface Mount Glass Passivated Ultrafast Rectifier

SUPERECTIFIER®

DO-214BA (GF1)
FEATURES

- Superectifier structure for high reliability condition
- Cavity-free glass-passivated junction
- Ideal for automated placement
- Ultrafast reverse recovery time
- Low switching losses, high efficiency
- High forward surge capability
- Meets environmental standard MIL-S-19500
- Meets MSL level 1, per J-STD-020, LF maximum peak of 250 °C
- AEC-Q101 qualified
- Compliant to RoHS Directive 2002/95/EC and in accordance to WEEE 2002/96/EC

RoHS
COMPLIANT

TYPICAL APPLICATIONS

For use in high frequency rectification and freewheeling application in switching mode converters and inverters for consumer, computer, automotive and telecommunication.

MECHANICAL DATA

Case: DO-214BA, molded epoxy over glass body
Molding compound meets UL 94 V-0 flammability rating
Base P/N-E3 - RoHS compliant, commercial grade
Base P/NHE3 - RoHS compliant, AEC-Q101 qualified

Terminals: Matte tin plated leads, solderable per J-STD-002 and JESD 22-B102
E3 suffix meets JESD 201 class 1A whisker test, HE3 suffix meets JESD 201 class 2 whisker test

Polarity: Color band denotes cathode end

PRIMARY CHARACTERISTICS	
$I_{F(AV)}$	1.0 A
V_{RRM}	50 V to 200 V
I_{FSM}	30 A
t_{rr}	50 ns
V_F	1.0 V
$T_J \text{ max.}$	175 °C

MAXIMUM RATINGS ($T_A = 25\text{ °C}$ unless otherwise noted)						
PARAMETER	SYMBOL	EGF1A	EGF1B	EGF1C	EGF1D	UNIT
Device marking code		EA	EB	EC	ED	
Maximum repetitive peak reverse voltage	V_{RRM}	50	100	150	200	V
Maximum RMS voltage	V_{RMS}	35	70	105	140	V
Maximum DC blocking voltage	V_{DC}	50	100	150	200	V
Maximum average forward rectified current at $T_L = 125\text{ °C}$	$I_{F(AV)}$	1.0				A
Peak forward surge current 8.3 ms single half sine-wave superimposed on rated load	I_{FSM}	30				A
Operating junction and storage temperature range	T_J, T_{STG}	- 65 to + 175				°C

EGF1A thru EGF1D

Vishay General Semiconductor



ELECTRICAL CHARACTERISTICS ($T_A = 25\text{ }^\circ\text{C}$ unless otherwise noted)							
PARAMETER	TEST CONDITIONS	SYMBOL	EGF1A	EGF1B	EGF1C	EGF1D	UNIT
Maximum instantaneous forward voltage	1.0 A	$V_F^{(1)}$		1.0			V
Maximum DC reverse current at rated DC blocking voltage	$T_A = 25\text{ }^\circ\text{C}$	$I_R^{(1)}$		5.0			μA
	$T_A = 125\text{ }^\circ\text{C}$			50			
Typical reverse recovery time	$I_F = 0.5\text{ A}$, $I_R = 1.0\text{ A}$, $I_{rr} = 0.25\text{ A}$	t_{rr}		50			ns
Typical junction capacitance	4.0 V, 1 MHz	C_J		15			pF

Note

(1) Pulse test: 300 μs pulse width, 1 % duty cycle

THERMAL CHARACTERISTICS ($T_A = 25\text{ }^\circ\text{C}$ unless otherwise noted)							
PARAMETER	SYMBOL	EGF1A	EGF1B	EGF1C	EGF1D	UNIT	
Typical thermal resistance	$R_{\theta JA}^{(1)}$	85				$^\circ\text{C/W}$	
	$R_{\theta JL}^{(1)}$	30					

Note

(1) Thermal resistance from junction to ambient and from junction to lead, PCB mounted on 0.2" x 0.2" (5.0 mm x 5.0 mm) copper pad areas

ORDERING INFORMATION (Example)					
PREFERRED P/N	UNIT WEIGHT (g)	PREFERRED PACKAGE CODE	BASE QUANTITY	DELIVERY MODE	
EGF1D-E3/67A	0.104	67A	1500	7" diameter plastic tape and reel	
EGF1D-E3/5CA	0.104	5CA	6500	13" diameter plastic tape and reel	
EGF1DHE3/67A ⁽¹⁾	0.104	67A	1500	7" diameter plastic tape and reel	
EGF1DHE3/5CA ⁽¹⁾	0.104	5CA	6500	13" diameter plastic tape and reel	

Note

(1) AEC-Q101 qualified

RATINGS AND CHARACTERISTICS CURVES

($T_A = 25\text{ }^\circ\text{C}$ unless otherwise specified)

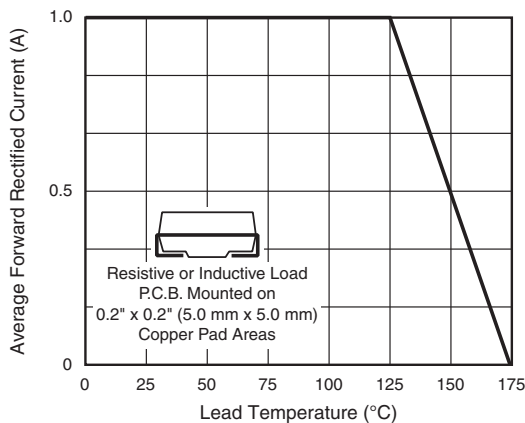

Fig. 1 - Maximum Forward Current Derating Curve

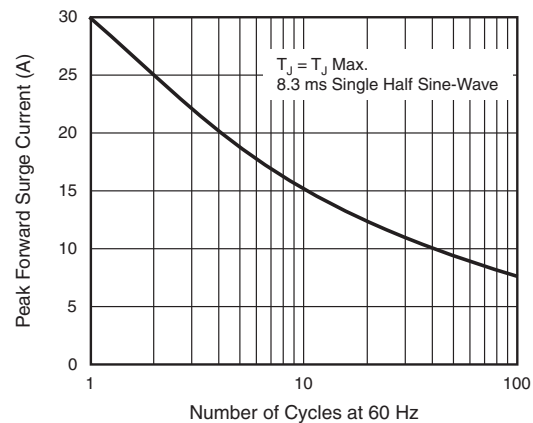

Fig. 2 - Maximum Non-Repetitive Peak Forward Surge Current

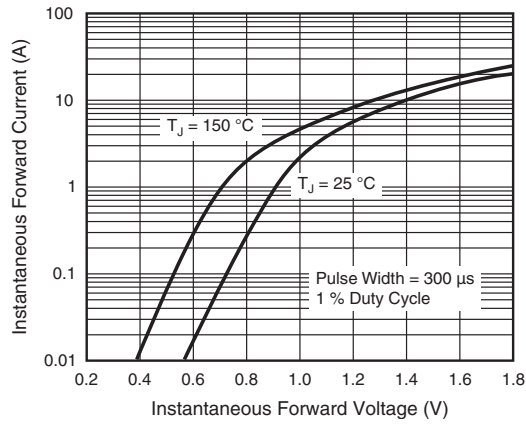

Fig. 3 - Typical Instantaneous Forward Characteristics

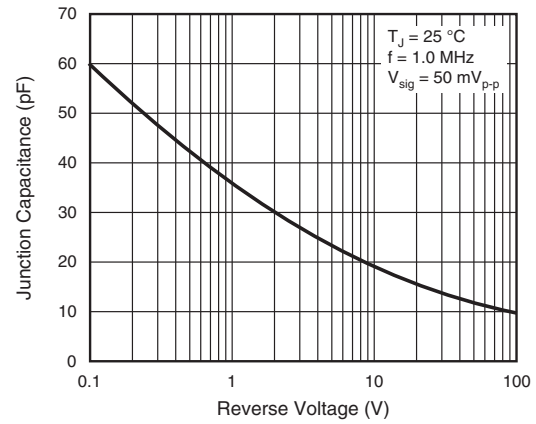

Fig. 5 - Typical Junction Capacitance

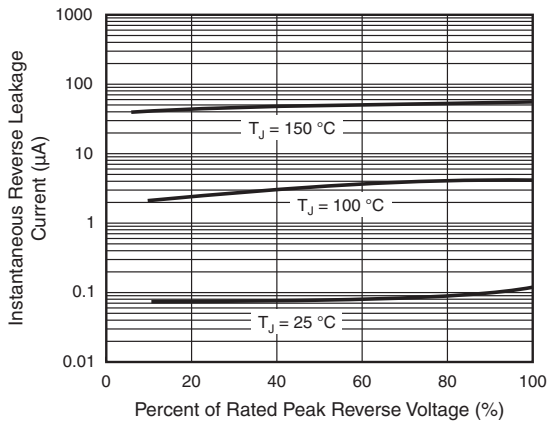

Fig. 4 - Typical Reverse Leakage Characteristics

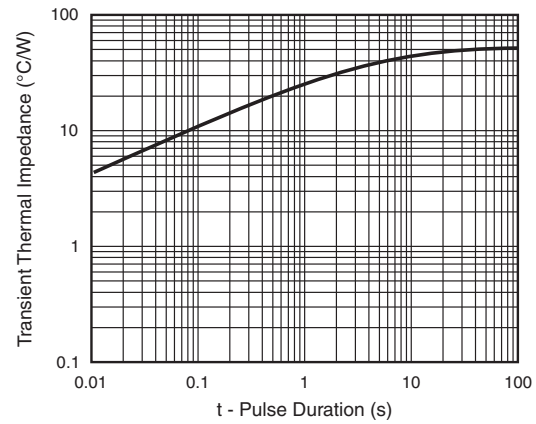
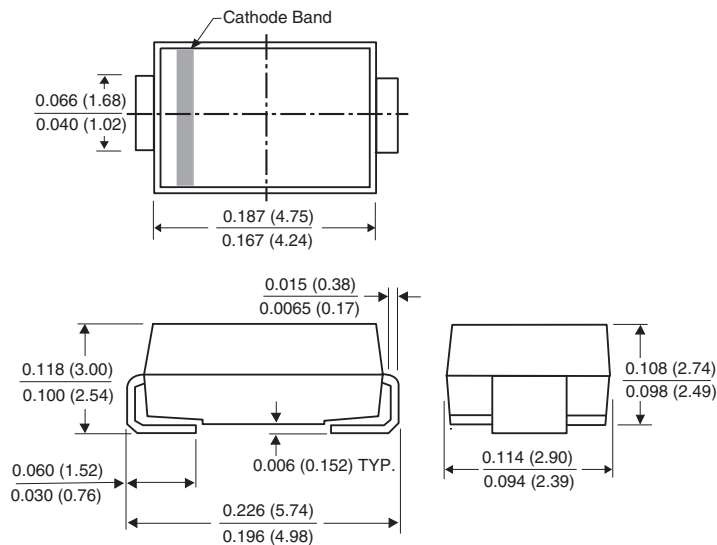

Fig. 6 - Typical Transient Thermal Impedance

PACKAGE OUTLINE DIMENSIONS in inches (millimeters)

DO-214BA (GF1)



Mounting Pad Layout

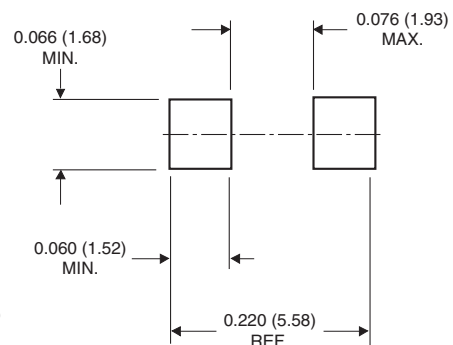



Disclaimer

ALL PRODUCT, PRODUCT SPECIFICATIONS AND DATA ARE SUBJECT TO CHANGE WITHOUT NOTICE TO IMPROVE RELIABILITY, FUNCTION OR DESIGN OR OTHERWISE.

Vishay Intertechnology, Inc., its affiliates, agents, and employees, and all persons acting on its or their behalf (collectively, "Vishay"), disclaim any and all liability for any errors, inaccuracies or incompleteness contained in any datasheet or in any other disclosure relating to any product.

Vishay makes no warranty, representation or guarantee regarding the suitability of the products for any particular purpose or the continuing production of any product. To the maximum extent permitted by applicable law, Vishay disclaims (i) any and all liability arising out of the application or use of any product, (ii) any and all liability, including without limitation special, consequential or incidental damages, and (iii) any and all implied warranties, including warranties of fitness for particular purpose, non-infringement and merchantability.

Statements regarding the suitability of products for certain types of applications are based on Vishay's knowledge of typical requirements that are often placed on Vishay products in generic applications. Such statements are not binding statements about the suitability of products for a particular application. It is the customer's responsibility to validate that a particular product with the properties described in the product specification is suitable for use in a particular application. Parameters provided in datasheets and/or specifications may vary in different applications and performance may vary over time. All operating parameters, including typical parameters, must be validated for each customer application by the customer's technical experts. Product specifications do not expand or otherwise modify Vishay's terms and conditions of purchase, including but not limited to the warranty expressed therein.

Except as expressly indicated in writing, Vishay products are not designed for use in medical, life-saving, or life-sustaining applications or for any other application in which the failure of the Vishay product could result in personal injury or death. Customers using or selling Vishay products not expressly indicated for use in such applications do so at their own risk. Please contact authorized Vishay personnel to obtain written terms and conditions regarding products designed for such applications.

No license, express or implied, by estoppel or otherwise, to any intellectual property rights is granted by this document or by any conduct of Vishay. Product names and markings noted herein may be trademarks of their respective owners.

Material Category Policy

Vishay Intertechnology, Inc. hereby certifies that all its products that are identified as RoHS-Compliant fulfill the definitions and restrictions defined under Directive 2011/65/EU of The European Parliament and of the Council of June 8, 2011 on the restriction of the use of certain hazardous substances in electrical and electronic equipment (EEE) - recast, unless otherwise specified as non-compliant.

Please note that some Vishay documentation may still make reference to RoHS Directive 2002/95/EC. We confirm that all the products identified as being compliant to Directive 2002/95/EC conform to Directive 2011/65/EU.

Vishay Intertechnology, Inc. hereby certifies that all its products that are identified as Halogen-Free follow Halogen-Free requirements as per JEDEC JS709A standards. Please note that some Vishay documentation may still make reference to the IEC 61249-2-21 definition. We confirm that all the products identified as being compliant to IEC 61249-2-21 conform to JEDEC JS709A standards.